

FRULLETTO NYLON ELICA



94PA646 - L190 mm















94PA656 - L300 mm

Punti di forza

- Battuta regolabile a bloccaggio rapido
- Design accattivante ed innovativo
- Rullo di protezione antigraffio
- Varie misure disponibili – anche maxi

Referenze

94PA6.. FRULLETTO NYLON ELICA

Cod.		L	L1	A	
94PA606		160	70	12/46	50
94PA646		190	70	12/76	50
94PA616		230	70	12/116	50
94PA656		300	100	12/156	50
94PA666		350	150	12/156	50
94PA60C		160	70	12/46	50
94PA64C		190	70	12/76	50
94PA61C		230	70	12/116	50
94PA65C		300	100	12/156	50
94PA66C		350	150	12/156	50

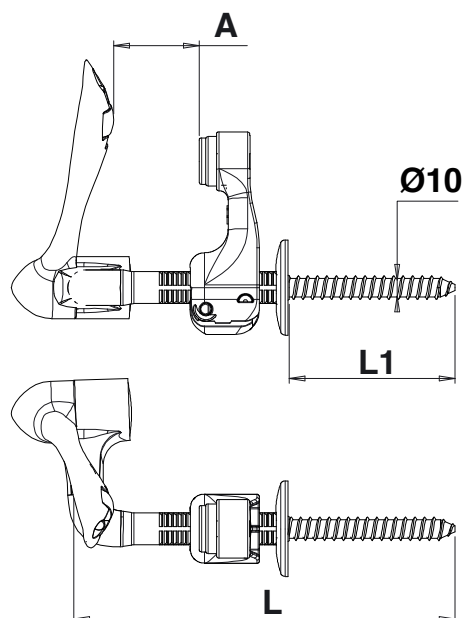

FRULLETTO NYLON ELICA

Battuta regolabile e montaggio rapido

Regolazione della battuta velocissima grazie al suo sistema di blocco a clips.

Battuta orientabile grazie all'asta dentellata.

Battuta ammortizzata con gommino para-colpo salva anta.

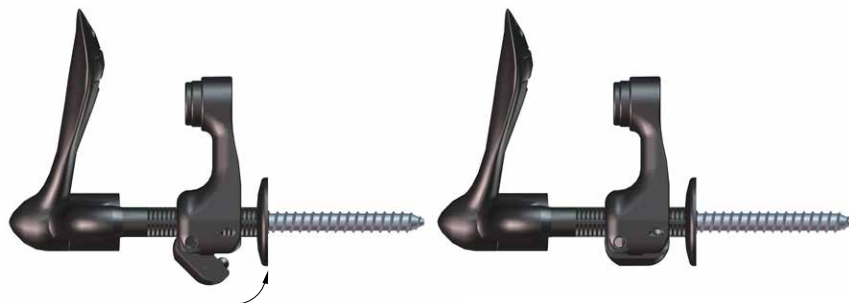

Design accattivante ed innovativo

Nuovo design più moderno e innovativo.



Rullo di protezione anti graffio

Evita il deterioramento dell'anta.



Rosetta di copertura

Finitura perfetta grazie alla rosetta di copertura.



Varie misure disponibili

Per ante singole ed impacchettate.
Ideali anche per muri con isolamento esterno.

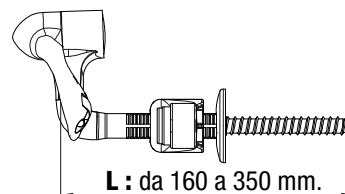

Punto di foratura rispetto alla posizione dell'anta

Da 15 a 20 mm sotto il bordo dell'anta.

