

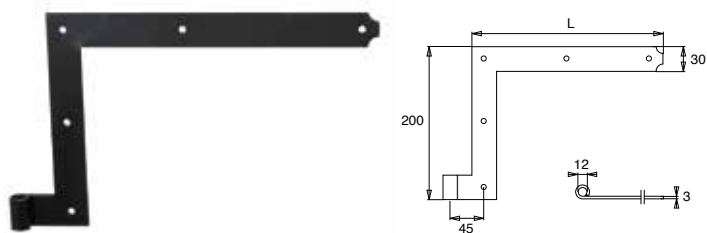

**Linea LEGNO M0**

[www.torbel.it](http://www.torbel.it)



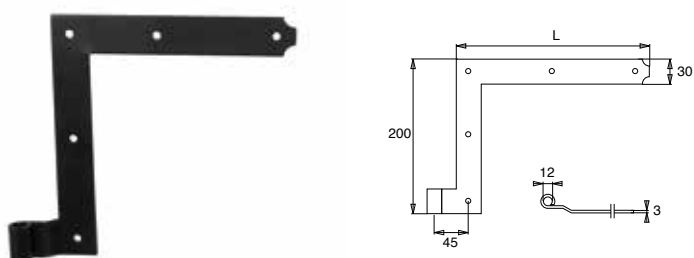

Cantonale

Cod.		L	
<b>Dx + sx</b>			
*GL370120E	9005	200	12 + 12
*GL370125E	9005	250	12 + 12
*GL370130E	9005	300	12 + 12
*GL370135E	9005	350	12 + 12
*GL370140E	9005	400	12 + 12



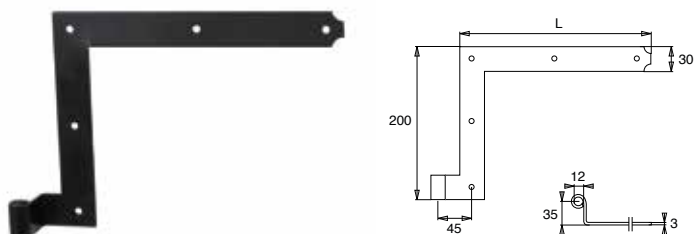

Cantonale piego a filo

Cod.		L	
<b>Dx + sx</b>			
*GL370220E	9005	200	12 + 12
*GL370225E	9005	250	12 + 12
*GL370230E	9005	300	12 + 12
*GL370235E	9005	350	12 + 12
*GL370240E	9005	400	12 + 12



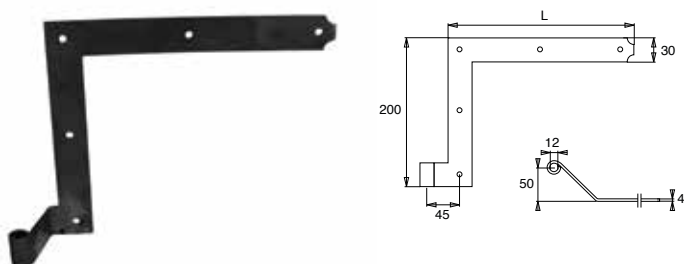

Cantonale ad angolo H.35

Cod.		L	
<b>Dx + sx</b>			
*GL370320E	9005	200	12 + 12
*GL370325E	9005	250	12 + 12
*GL370330E	9005	300	12 + 12
*GL370335E	9005	350	12 + 12
*GL370340E	9005	400	12 + 12



Cantonale ad angolo H.50 x filo

Cod.		L	
<b>Dx + sx</b>			
*GL370420E	9005	200	12 + 12
*GL370425E	9005	250	12 + 12
*GL370430E	9005	300	12 + 12
*GL370435E	9005	350	12 + 12
*GL370440E	9005	400	12 + 12

\* Fabbricazione su richiesta.



Tappo per cantonale

Cod.		
GL270080E		100

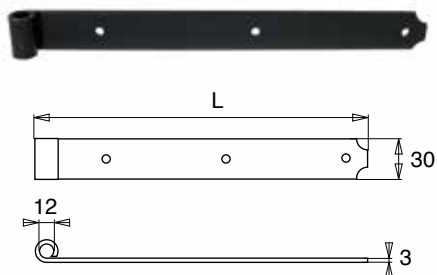

Bandella

Cod.		L	
GL213120E	9005	200	48
GL213125E	9005	250	48
GL213130E	9005	300	48
GL213135E	9005	350	48
GL213140E	9005	400	48
GL213150E	9005	500	48

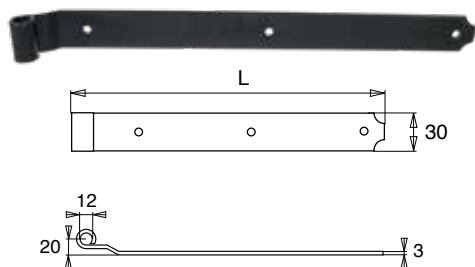

Bandella piego a filo

Cod.		L	
*GL213220E	9005	200	48
*GL213225E	9005	250	48
*GL213230E	9005	300	48
*GL213235E	9005	350	48
*GL213240E	9005	400	48
*GL213250E	9005	500	48

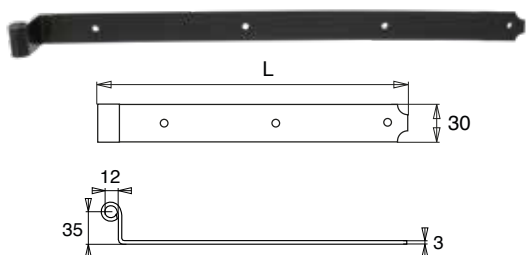

Bandella ad angolo H.35

Cod.		L	
*GL213320E	9005	200	48
*GL213325E	9005	250	48
*GL213330E	9005	300	48
*GL213335E	9005	350	48
*GL213340E	9005	400	48
*GL213350E	9005	500	48

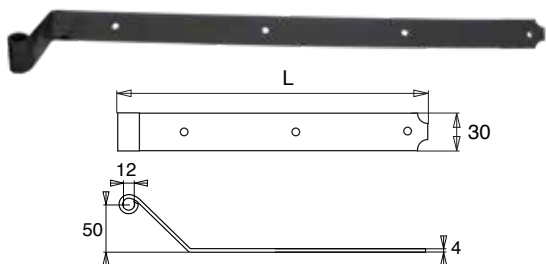

Bandella ad angolo H.50 x filo

Cod.		L	
*GL213420E	9005	200	48
*GL213425E	9005	250	48
*GL213430E	9005	300	48
*GL213435E	9005	350	48
*GL213440E	9005	400	48
*GL213450E	9005	500	48

\* Fabbricazione su richiesta.

## Ferri a T

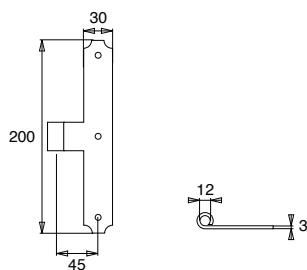

### Ferro a T

Cod.



GL400100E **9005** 48

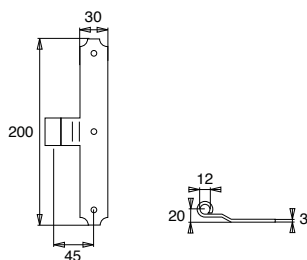

### Ferro a T piego a filo

Cod.



\*GL400200E **9005** 48

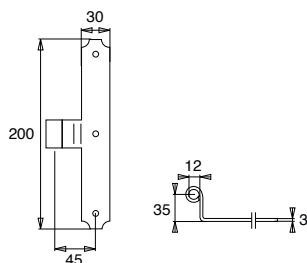

### Ferro a T ad angolo H.35

Cod.



\*GL400300E **9005** 48

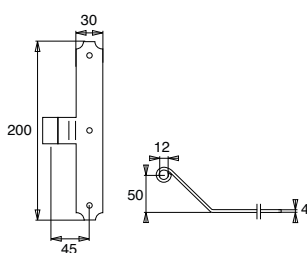

### Ferro a T ad angolo H.50 x filo

Cod.



\*GL400400E **9005** 48

\* Fabbricazione su richiesta.

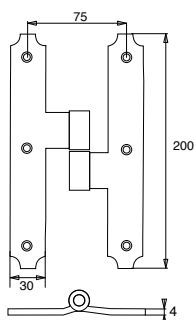

**Cerniera H sfilabile 75 mm**

Cod.



**Dx**

GL250500E **9005** 24

**Sx**

GL251500E **9005** 24

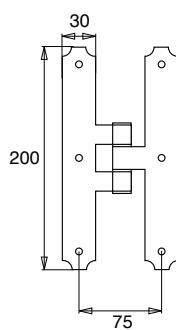

**Cerniera H fissa 75 mm**

Cod.



GL250600E **9005** 24

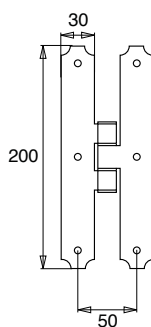

**Cerniera H fissa stretta 50 mm**

Cod.



GL250700E **9005** 24

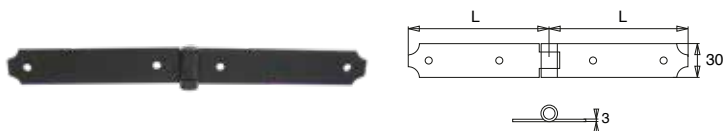

**Cerniera doppia**

Cod.		L	
GL500012E	9005	120 + 120	48

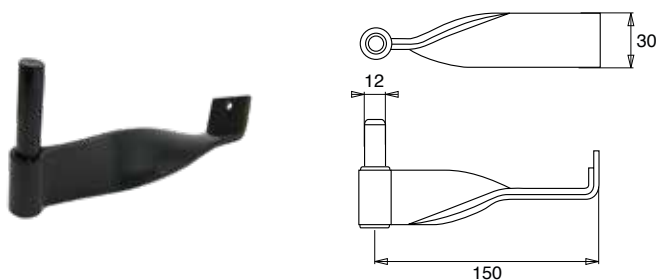

**Cardine a murare**

Cod.		
GL131215E	9005	48



**Cardine chimico Ø12  
perno sfilabile + brugola**

Cod.		L	ØD	ØM	
<b>Dx</b>					
GL150901E	9005	90	12	M12	12
GL151301E	9005	135	12	M12	24
GL151801E	9005	180	12	M12	24
<b>Sx</b>					
GL150902E	9005	90	12	M12	12
GL151302E	9005	135	12	M12	24
GL151802E	9005	180	12	M12	24

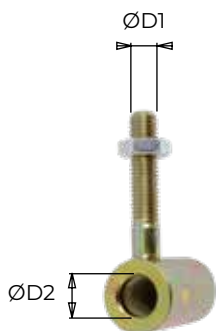

**Dima per cardine chimico**

Cod.		ØD1	ØD2	
GL99BSM0		M12	16	1

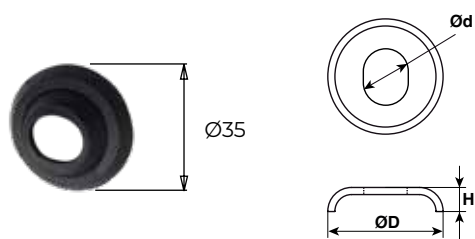

**Rosetta di copertura a muro**

Cod.		H	ØD	Ød	
GL1702R12		9	35	12	1000

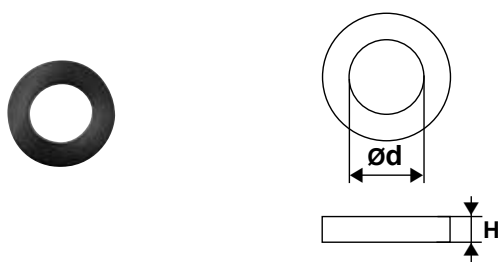

**Rondella ferro**

Cod.		H	ØD	
GLA0333		3	12	100

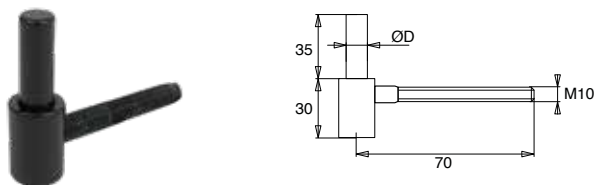

**Cardine Anuba**

Cod.		L	ØM	ØD		
GL170112E		9005	70	10	12	30

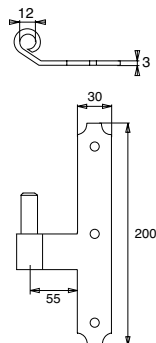

**Cardine a T  
per muri paramano H15**

Cod.



**Dx**

GL182001E **9005** 24

**Sx**

GL182002E **9005** 24

Interasse occhiolo - 1° foro 60 mm.

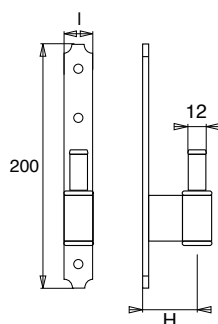

**Cardine su piastra Ø12**

Cod.		I	H	-	
GL112020E	<b>9005</b>	20	21	FILO	48
GL112024E	<b>9005</b>	20	25	BAT 15	48
GL112029E	<b>9005</b>	20	29	BAT 20	48
*GL112034E	<b>9005</b>	20	34	BAT 25	48
*GL112050E	<b>9005</b>	20	50	BAT 15	48
*GL112055E	<b>9005</b>	20	55	BAT 20	48
GL112520E	<b>9005</b>	25	21	FILO	48
GL112524E	<b>9005</b>	25	25	BAT 15	48
GL112529E	<b>9005</b>	25	29	BAT 20	48
*GL112534E	<b>9005</b>	25	34	BAT 25	48
*GL112550E	<b>9005</b>	25	50	BAT 15	48
*GL112555E	<b>9005</b>	25	55	BAT 20	48

\* Fabbricazione su richiesta.



## Cardini pesanti

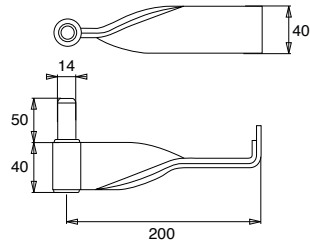

### Cardine a murare pesante

Cod.



GLI31415E **9005** 24

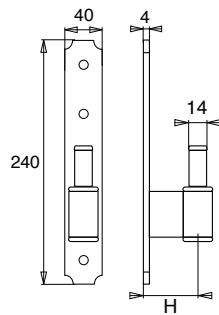

### Cardine su piastra pesante Ø14

Cod.



GLIP4030E **9005** 30 24

GLIP4040E **9005** 40 24

Altre Battute a richiesta.

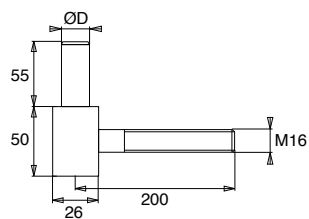
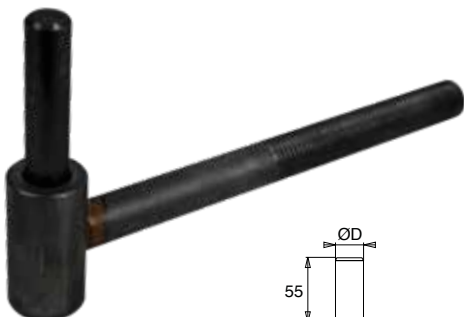

### Cardine chimico pesante Ø14

Cod.



GLI5P000E **9005** 200 16 14 10

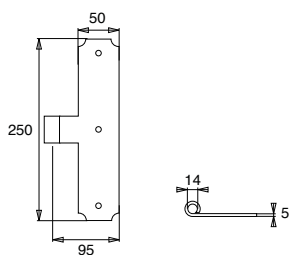

**Ferro a T pesante 50x5 Ø14**

Cod.		
GL40P000E <b>9005</b>	1	

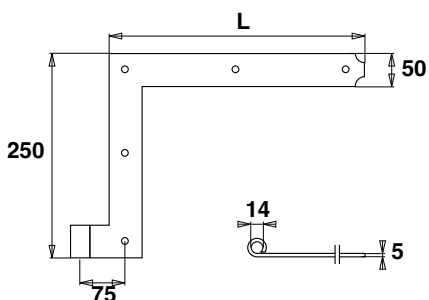
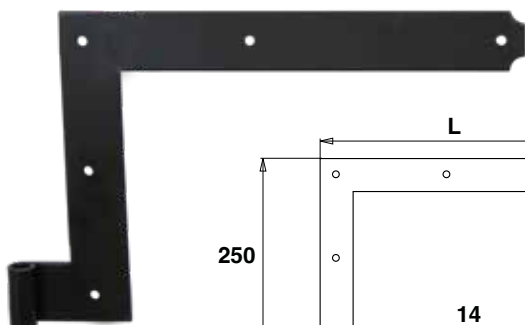

**Cantonale pesante 50x5 Ø14**

Cod.		L	
*GL37P050E <b>9005</b>		500	1+1
*GL37P060E <b>9005</b>		600	1+1
*GL37P070E <b>9005</b>		700	1+1
*GL37P080E <b>9005</b>		800	1+1
*GL37P090E <b>9005</b>		900	1+1
*GL37P100E <b>9005</b>		1000	1+1

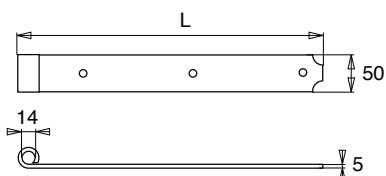









**Bandella pesante 50x5 Ø14**

Cod.		L	
GL21P550E <b>9005</b>		500	6
GL21P560E <b>9005</b>		600	6
GL21P570E <b>9005</b>		700	6
GL21P580E <b>9005</b>		800	6
GL21P590E <b>9005</b>		900	6
GL21P5100E <b>9005</b>		1000	6
GL21P5120E <b>9005</b>		1200	6

\* Fabbricazione su richiesta.



**Catenaccio verticale**

Cod.		H	
GL6003003		300	1
GL6004003		400	1
GL6005003		500	1
GL6006003		600	1
GL6008003		800	1
GL6001003		1000	1



**Catenaccio trasversale  
280x140**

Cod.		
GL6011003		1

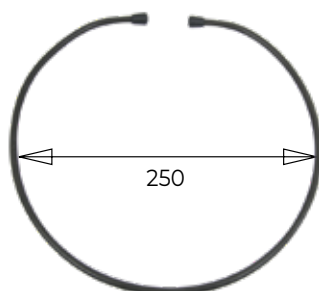

**Molle temperate per coprifili**

Cod.		
GL3002503		24

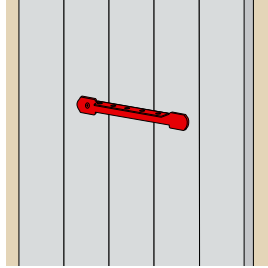
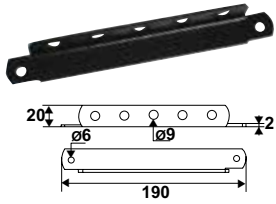

**Cremagliera L**

Cod.



9241014

1

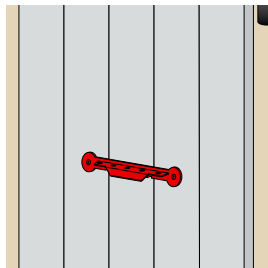
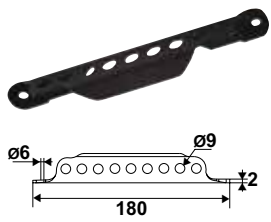

**Cremagliera TORBEL®**

Cod.



9241054

1

Un prodotto per una doppia funzione, la cremagliera TORBEL® serve anche da maniglia per tirare l'anta a se.

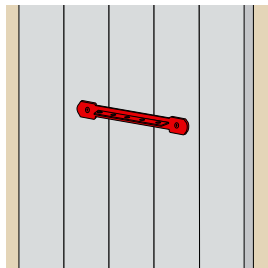
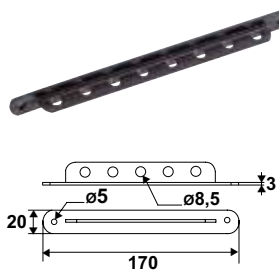

**Cremagliera T**

Cod.



9241174

1

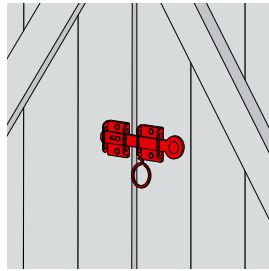
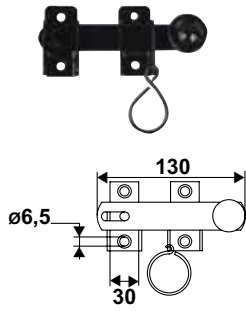

Chiusura per persiana

Cod.		
9101036		50

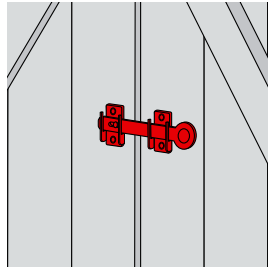
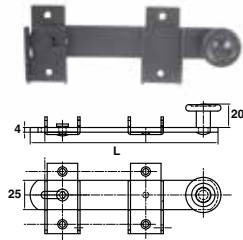

Chiusura per persiana

Cod.		L	
J529202		160	10
J529203		190	10

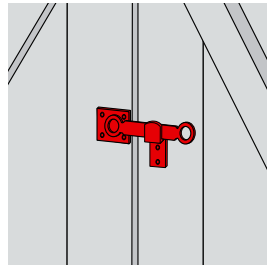
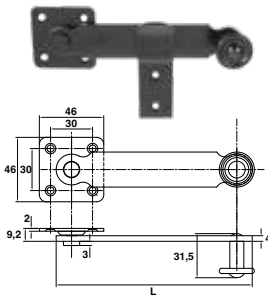

Chiusura per persiana

Cod.		L	
J528214		140	10
9201204		160	50
J528219		190	10

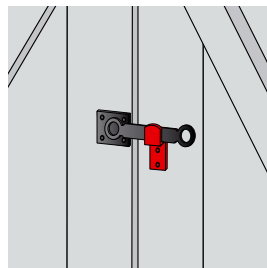
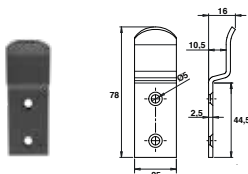

Incontro chiusura

Cod.		
J528186		50

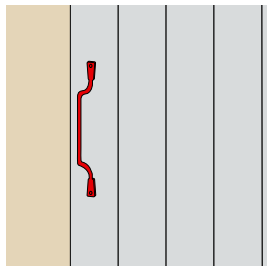
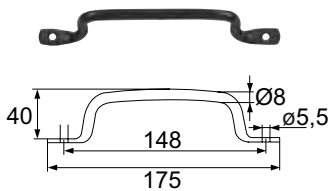

Maniglia per persiana

Cod.		
9201024		25

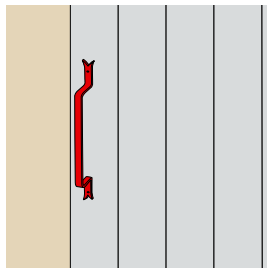
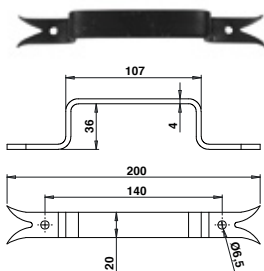



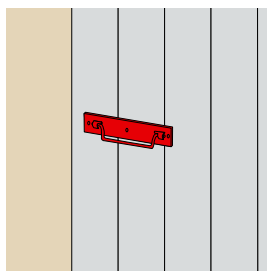
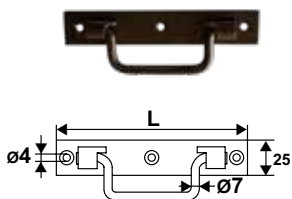

Maniglia per persiana

Cod.		
P38503600		50



Maniglia per persiana su piastra

Cod.		L	
9201086		120	12
9201094		140	12



Punti di forza

- Un codice articolo, 2 prodotti.
- Cremagliera TORBEL® a doppia funzione : aggancio regolabile e maniglia per persiana.
- Puntaletto con anello ad avvitare : consente una regolazione millimetrica dopo la foratura.
- Finitura: cataforesi o zincatura.

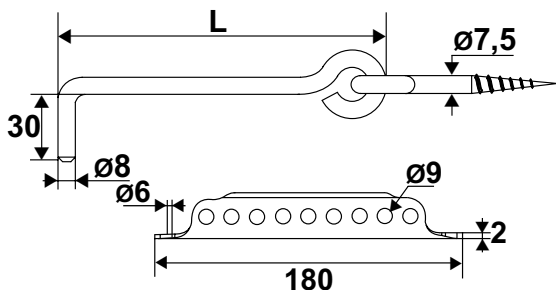

Puntaletto Ø8 ad avvitare + cremagliera TORBEL® ferro

Cod.		L	
9243304		300	12
9243354		350	12
9243404		400	12
9243454		450	12
9243504		500	12
9243554		550	12
9243604		600	12
9243302		300	12
9243352		350	12
9243402		400	12
9243452		450	12
9243502		500	12
9243602		600	12

Braccio Ø8 su piastra + cremagliera TORBEL®

Cod.		L	
9240304		300	12
9240404		400	12
9240454		450	12

